

Raychem E-100-A AND E-100-L-A END SEAL AND LIGHTED END SEAL KITS

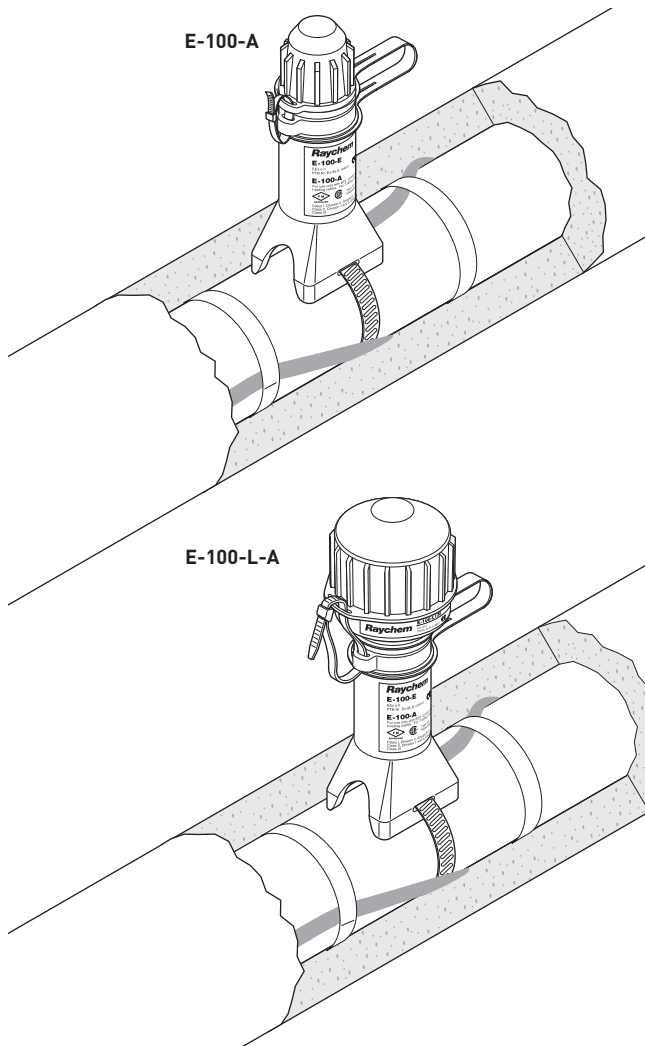

PRODUCT OVERVIEW

The E-100-A and E-100-L-A serve as above-insulation end seal kits for Raychem brand BTV, QTVR, XTV, KTV, or VPL heating cables. They are approved by FM and CSA for use in hazardous locations.

Both the E-100-A and the E-100-L-A are mounted on the pipe and project through the thermal insulation and cladding for ease of maintenance. The E-100-L-A end seal with signal light uses an array of bright LEDs for exceptional visibility and long product life.

These rugged end seals are made from high-performance engineering polymer and resist impact, high temperature, and chemical and UV exposure. The stand allows for up to four inches (100 mm) of thermal insulation. The encapsulated light and boot reliably prevent moisture and dust ingress. The industrial-grade electronics used in the E-100-L-A are encapsulated.

Both the E-100-A and E-100-L-A are re-enterable, allowing easy access for testing. Voltage and continuity checks can be done by simply unscrewing the E-100-A cap and removing the reusable sealing boot. The E-100-L-A makes maintenance even easier by allowing for visual inspection of heating circuit continuity. The E-100-L-A is available in two voltages and can be retrofitted into previously installed E-100-A end seals. The light module is replaceable.

The kits contain all the necessary materials for a complete installation except for one pipe strap, which must be ordered separately.

	E-100-A	E-100-L-A
DESCRIPTION	Above-insulation end seal, cold-applied	Above-insulation end seal with red signal light, cold-applied *Not for use with 480 V VPL
KIT CONTENTS	1 end seal	1 end seal with red indicator light





Note: Order appropriate pipe strap separately (one per kit)

E-100-A

E-100-L-A





APPROVALS

Hazardous Locations

 Class I, Div. 2, Groups A, B, C, D
 Class II, Div. 1 and 2, Groups E, F, G
 Class III
 -ws
 (1)
 CLI, ZN1, AEx e II T⁽²⁾
 APPROVED
 -ws Ex e II T⁽²⁾
IECEX IECEx PTB 09.0038U
 Ex e II Ex tD A21 IP66
 09-IEEx-0004X
 Ex e IIC T* Gb

⁽¹⁾ Except VPL
⁽²⁾ For T-rating, see heating cable or design documentation

Hazardous Locations

 Class I, Div. 2, Groups A, B, C, D
 Class II, Div. 1 and 2, Groups E, F, G
 Class III
 -ws
 (1)
 CLI, ZN1, AEx em II T⁽²⁾
 APPROVED
 -ws Ex em II T⁽²⁾
IECEX IECEx PTB 09.0038U
 Ex emb II
 Ex tD mbD A21 IP66
 09-IEEx-0004X
 Ex e IIC T* Gb

E-100-A

E-100-L-A

PRODUCT SPECIFICATIONS

Heating cable capability	BTV-CR, BTV-CT, QTVR-CT, XTV-CT, KTV-CT and VPL-CT	
Ingress protection	NEMA 4X (IP65)	NEMA 4X (IP65)
Minimum installation temperature	-40°F (-40°C)	-40°F (-40°C)
Minimum ambient temperature	-75°F (-60°C)	-40°F (-40°C)
Maximum ambient temperature	132°F (56°C)	104°F (40°C)
Maximum pipe temperature	500°F (260°C)	500°F (260°C)
Maximum operating voltage	480 Vac	120 / 277 Vac
Overall height	7 in (175 mm)	8 in (200 mm)
Outer diameter at insulation	2.0 in (50 mm) Usable with up to 4 in (100 mm) thermal insulation	3 in (75 mm)
Materials	High-performance glass-filled engineered polymer	High-performance glass-filled engineered polymer
Light source		Super-bright light-emitting diodes (LEDs), red
Light source power supply	Not applicable	Linear (nonswitching)
Power consumption	0 W	< 2 W

E-100-A**E-100-L-A****ORDERING DETAILS****End seal**

Catalog number	E-100-A (100–480 Vac)	E-100-L1-A (100–120 Vac)	E-100-L2-A (200–277 Vac)
Part number	046567-000	583377-000	478767-000
Weight	0.6 lb (272 g)	1.3 lb (630 g)	1.3 lb (630 g)

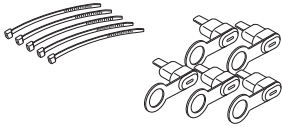
Spare boot pack for E-100

Catalog number	E-100-BOOT-5-PACK
Part number	281053-000
Pack weight	0.25 lb (140 g)
Pack contents	Five sealant-filled boots and five cable ties

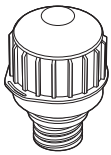
Replacement indicator light for E-100-LXX-A

Catalog number	E-100-LR1-A (100–120 Vac)	E-100-LR2-A (200–277 Vac)
Part number	552225-000	874485-000
Weight	0.9 lb (450 g)	0.9 lb (450 g)



WWW.PENTAIRTHERMAL.COM

NORTH AMERICA

Tel: +1.800.545.6258
Fax: +1.800.527.5703
Tel: +1.650.216.1526
Fax: +1.650.474.7711
thermal.info@pentair.com

EUROPE, MIDDLE EAST, AFRICA

Tel: +32.16.213.511
Fax: +32.16.213.603
thermal.info@pentair.com

ASIA PACIFIC

Tel: +86.21.2412.1688
Fax: +86.21.5426.2917
cn.thermal.info@pentair.com

LATIN AMERICA

Tel: +1.713.868.4800
Fax: +1.713.868.2333
thermal.info@pentair.com

Pentair, BTV, QTVR, XTV, KTV, and VPL are owned by Pentair or its global affiliates. All other trademarks are the property of their respective owners. Pentair reserves the right to change specifications without prior notice..

© 2001–2013 Pentair.